

PHILIPS

dynalite

PDUVCC

DACM Language Kit 1



Installation Instructions

Instructions d'installation
Istruzioni per l'installazione
Instrucciones de instalación

 Devices must be installed in an approved enclosure by a qualified electrician in accordance with all national and local electrical and construction codes and regulations.

I dispositivi devono essere installati da un elettricista qualificato in un luogo approvato, in conformità a tutti gli standard e le norme nazionali e locali vigenti in materia di impianti elettrici e costruzioni edilizie.

Les appareils doivent être installés dans un lieu jugé apte, par un électricien qualifié et conformément aux règles et normes locales et nationales en matière d'électricité et de construction.

Los dispositivos se deben instalar en un recinto aprobado por un electricista cualificado de acuerdo a todos los reglamentos eléctricos y de construcción locales y nacionales pertinentes

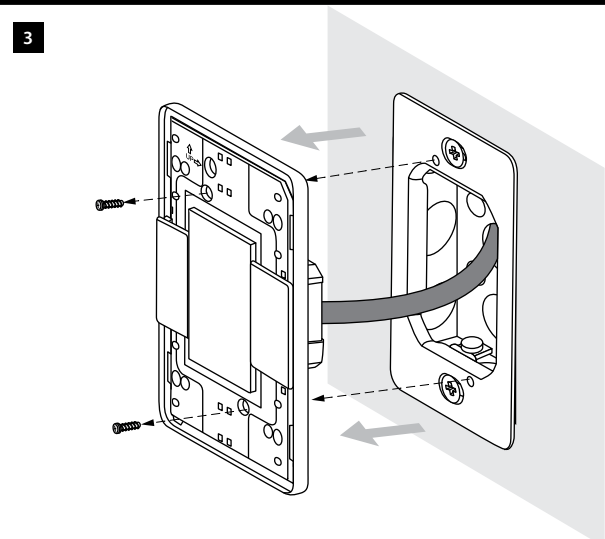
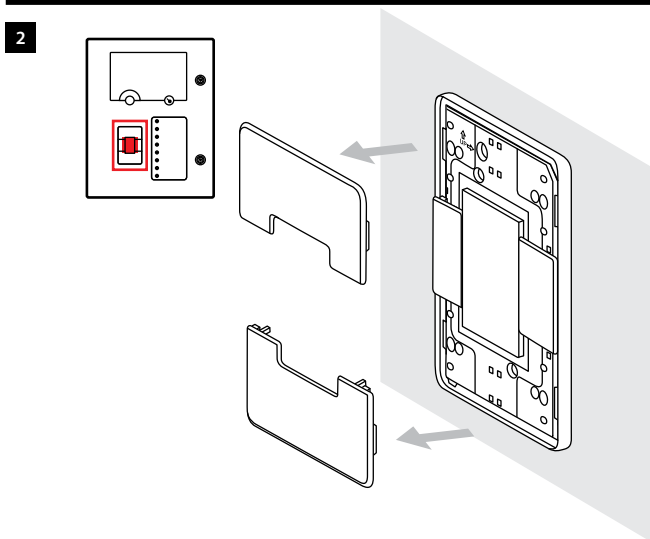
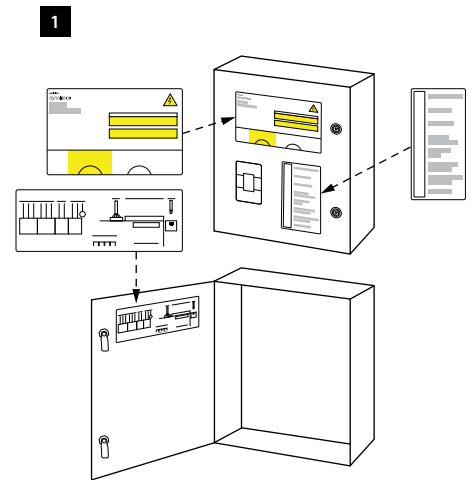
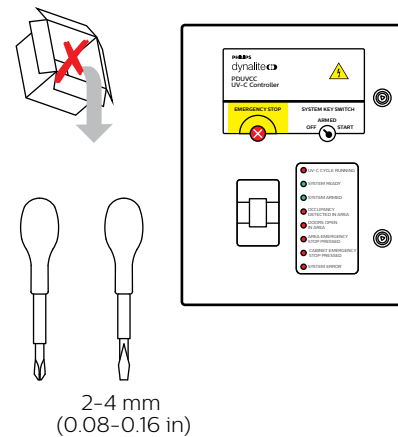
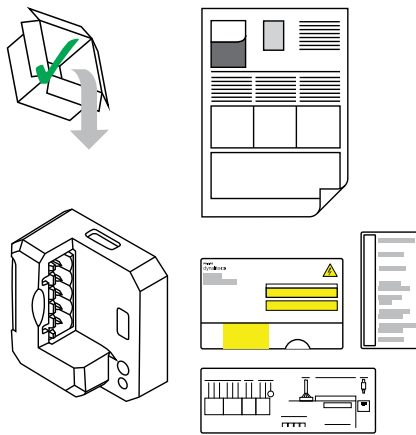

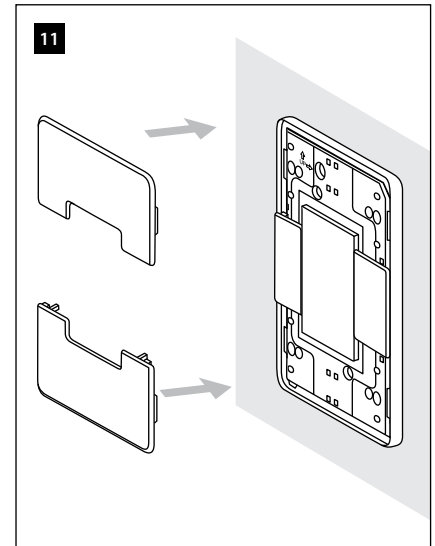
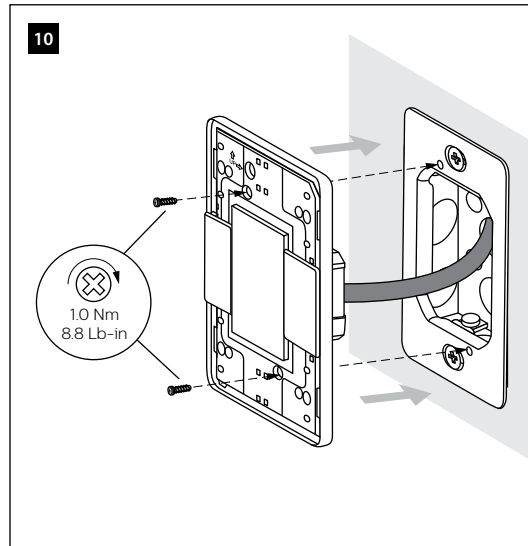
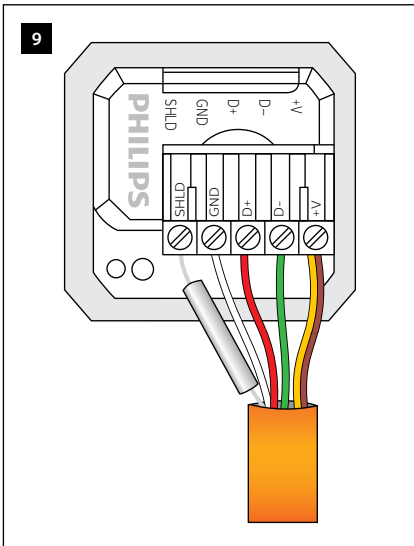
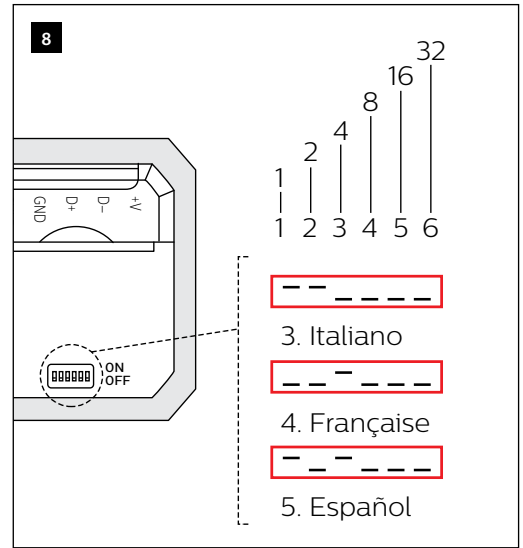
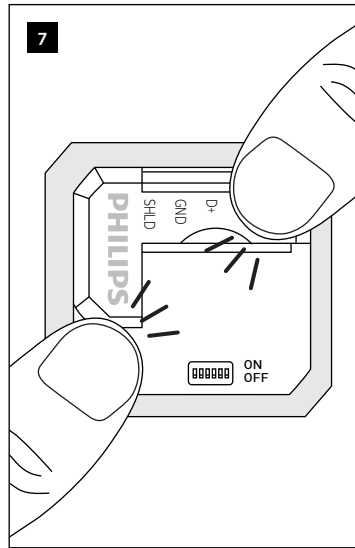
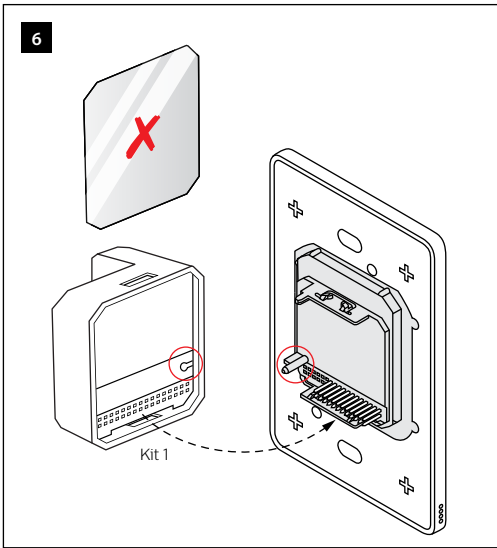
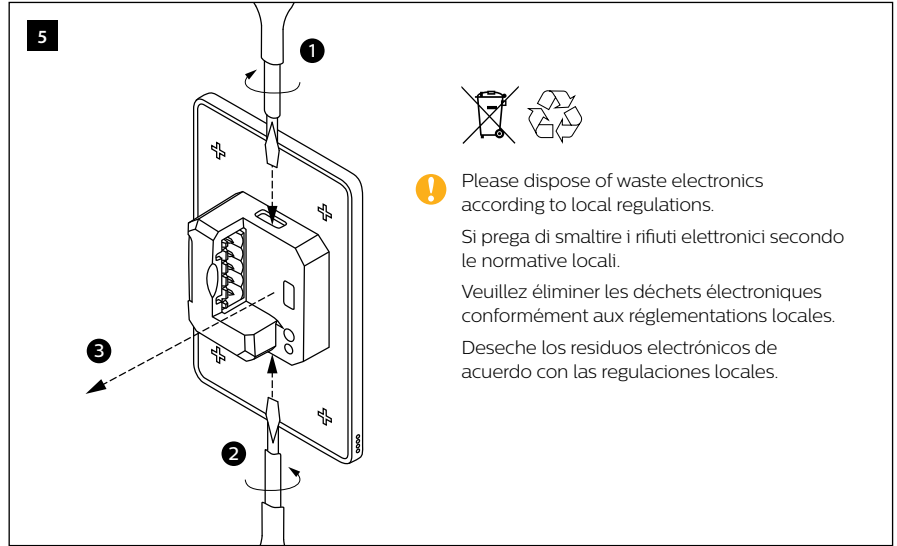
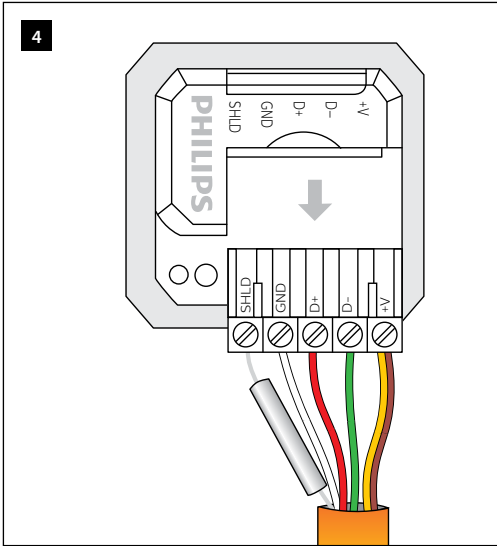

- A** This is a class A product. In a domestic environment this product may cause radio interference, in which case the user may be required to take adequate measures.
- E** Installation of a home and building automation and control system shall comply with IEC 60364 (all parts). The temperature limits and current-carrying capacities for the communication wires specified in IEC 60364-5-52 shall not be exceeded.

