



DTK622-232

Serial Port Node

Serial port connection node

The Philips Dynalite DTK622 is a network gateway that provides passive integration to a PC or RS-232 system.

DTK622-232

Serial port connection node

- **Full duplex integration** – Useful for linking a Philips Dynalite system with an AV or air conditioning system that supports RS-232.

Dimensions

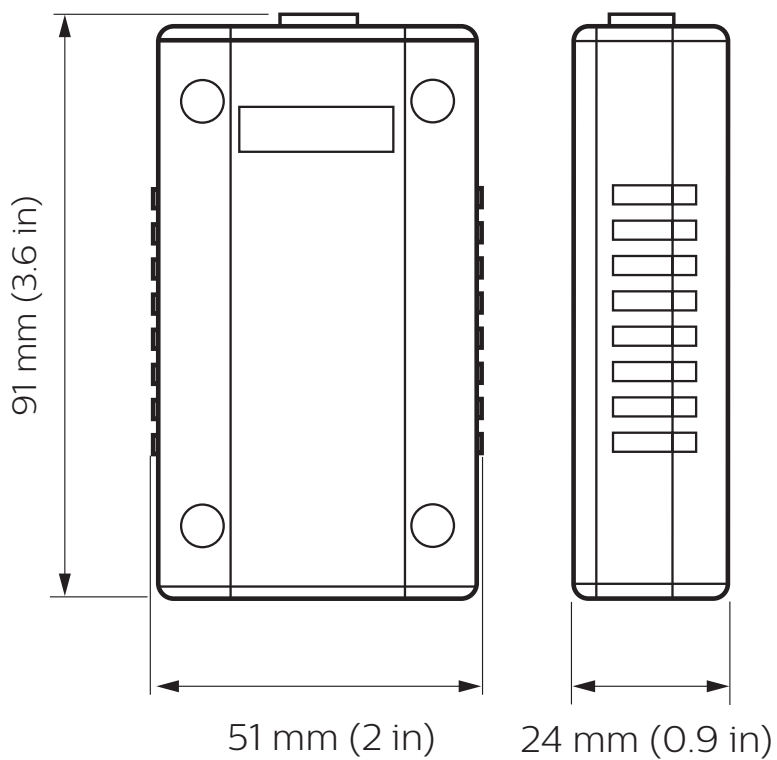

Specifications

Due to continuous improvements and innovations, specifications may change without notice.



DTK622-232
Serial Port Node

Electrical

Supply Type	DyNet
Supply Voltage	12 VDC
Supply Current	20 mA
IEC Overvoltage Category	III

Control

Serial Ports	2 x RS-485 1 x RS-232
Supported Protocols	DyNet
Indicators	1 x DyNet power LED

Physical

Dimensions (H x W x D)	24 x 51 x 91 mm (0.9 x 2.0 x 3.6 in)
Packed Weight	94 g (0.2 lb)
Construction	ABS plastic
Serial Ports	2 x RJ12 1 x D9 Female

Environment*

Operating Temperature	0° to 40°C ambient (32° to 104°F)
Storage/Transport Temperature	-25° to 60°C ambient (-13° to 140°F)
Humidity	0 to 90% non-condensing
IEC Pollution Degree	II

Compliance

Certification	CE, RCM, UKCA, RoHS
---------------	---------------------

* For indoor installation only

Electrical

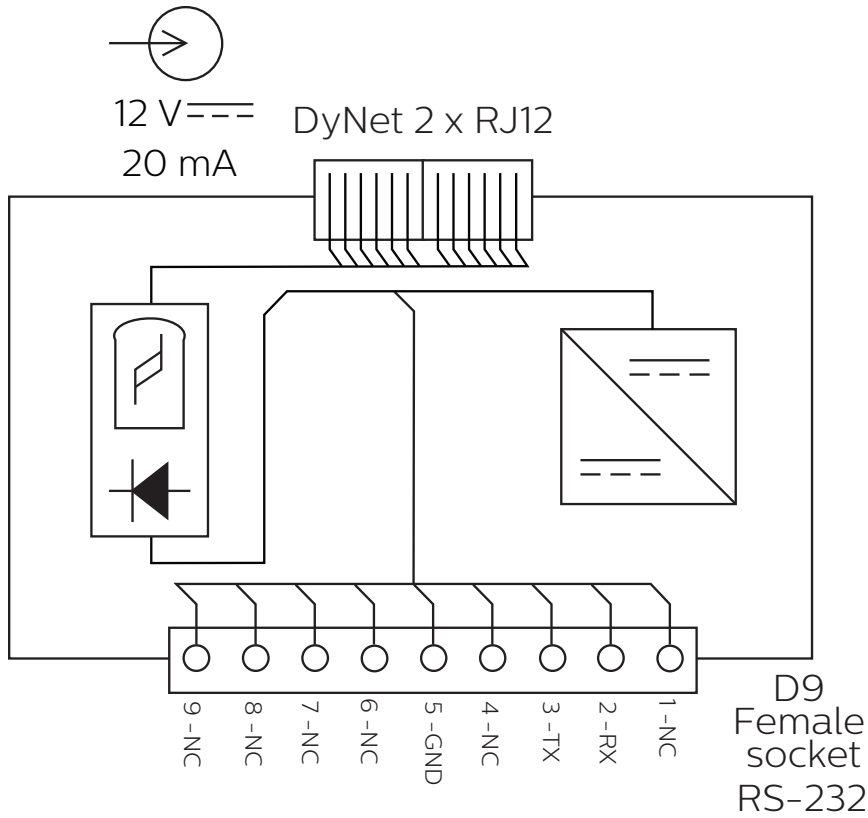

Ordering Code

Product

DTK622-232

Philips 12NC

913703090109

Accessories (Supplied)

1 x RS-232 Male-to-Female Cable

1 x RJ12 Cable

1 x 5-pin RJ12 dingus



© 2022 Signify Holding. All rights reserved. Specifications are subject to change without notice. No representation or warranty as to the accuracy or completeness of the information included herein is given and any liability for any action in reliance thereon is disclaimed. Philips and the Philips Shield Emblem are registered trademarks of Koninklijke Philips N.V. All other trademarks are owned by Signify Holding or their respective owners.